

FLECK

RECESSED 30% TRUE, LEADED CRYSTAL STARLIGHT
IP67/IP65 INDOOR/OUTDOOR

MINIM.IS/fleck

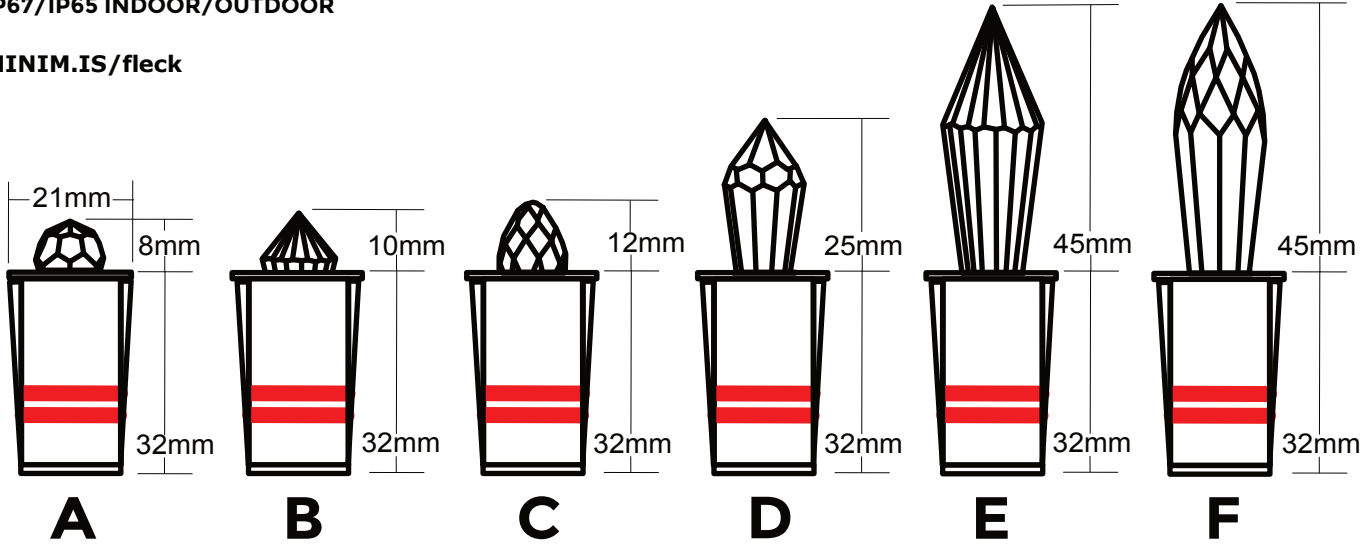

SPECIFICATIONS

MATERIAL:	PRECISION, HAND-MILLED TITANIUM	WARRANTY:	5-YEAR LIMITED WARRANTY
OPTICS:	CHOICE AMONG SIX 30% LEADED CRYSTAL FORMS, SUBJECT TO AVAILABILITY; DIMENSIONS +/- 2MM	LUMINAIRE WEIGHT:	0.1 LB (45 GRAMS)
PIGTAIL:	23-INCH (58CM) DOUBLE-SHEATHED PIGTAIL	POWER RATING:	125mA @ 12vDC = 1.5 watt
POWER REQUIREMENT:	CONSTANT VOLTAGE 12-VOLT DC, PARALLEL TOPOLOGY	LUMEN OUTPUT:	38 LM (DELIVERED)
ENVIRONMENT:	IP67, IP65, DAMP, WET, DRY, IC, CONCRETE, DRYWALL		

HOW TO SPECIFY. LUMINAIRE EXAMPLE CODE: FL-MP-30-E-TI-TRKTRD16-PKMP-1630-DAL

PROD.	FAMILY	CCT & CRI	OPTICS ⁵	BEZEL COLOR	TRIM KIT	POWER KIT ¹	DIMMING PROTOCOLS ⁵
FL	MP	27	2700°K CRI 90+	A 8MM H LEADED CRYSTAL	TI NATURAL TITANIUM	TRKTRD16 ²	10V 0-10VDC + 10V PWM ³ DL1 DALI + 10V PWM ³ DL2 DALI-2 + 10V PWM ³ N/A NO POWER
		30	3000°K CRI 90+	B 10MM H LEADED CRYSTAL	AU MATTE GOLD ³	NOKIT	
		35	3500°K CRI 90+	C 12MM H LEADED CRYSTAL	BK MATTE BLACK ³		
		40	4000°K CRI 90+	D 25MM H LEADED CRYSTAL			
		45	4500°K CRI 90+	E 45MM H LEADED CRYSTAL			
		50	5000°K CRI 90+	F 45MM H LEADED CRYSTAL			

- 1 KIT TO POWER 1-15 LIGHTS OR 16-30 LIGHTS. DATA SHEET: <https://minim.is/cutsheet/CUT-SHEET-PKMPXXX.pdf>
- ALL-TITANIUM CONCRETE / PLASTER TRIM KIT "BEFORE THE POUR." DATA SHEET: <https://minim.is/cutsheet/CUT-SHEET-TRKTXXX.pdf>
- SUBJECT TO AVAILABILITY, ADDITIONAL CHARGE, AND LEAD TIMES. INCORRECT CHOICE RESULTS IN RESTOCKING FEE.
- CRYSTALS ARE HAND-FACETED. MAY RESULT IN MINOR, OFF-CENTER ORIENTATION. DIMENSIONS +/- 4MM.
- A MINIMUM OF THREE (3) LUMINAIRES ARE REQUIRED MEET DIMMING "MINIMUM LOAD" OBLIGATIONS. DIMMING LESS THAN THREE (3) WILL INVALIDATE WARRANTY.
- CRYSTALS ARE EXCEEDINGLY FRAGILE. WARRANTY DOES NOT COVER BREAKAGE IN THE FIELD.



WARRANTY NOTES + DISCLAIMER

MALFUNCTION AND/OR DAMAGE TO PRODUCT DUE TO EMPLOY OF INCOMPATIBLE OR DEFECTIVE DIMMING SYSTEM / PROTOCOL, OR DUE TO DISREGARD OF INSTALLATION INSTRUCTIONS WILL NOT BE COVERED UNDER WARRANTY. CONTACT MINIMIS FOR RECOMMENDED POWER SOURCES. **MAINS DIMMING WILL INVALIDATE WARRANTY.**

IF FIXTURE IS TO BE INSTALLED WITH A DIMMER OR DIMMING CONTROL SYSTEM A MINIMUM OF THREE (3) LUMINAIRES ARE REQUIRED MEET DIMMING "MINIMUM LOAD" OBLIGATIONS. DIMMING LESS THAN THREE (3) WILL INVALIDATE WARRANTY. CONSULT A DIMMING SYSTEM MANUFACTURER WITH MINIMUM LOAD BEFORE INSTALLING.

MINIMIS RESERVES THE RIGHT AT ITS SOLE DISCRETION TO MAKE DESIGN CHANGES TO OUR PRODUCTS, AT ANY TIME, AND WITHOUT ADVANCE NOTICE.

CONSULT US: +1 305 503 5779 or WWW.MINIM.IS/contact

MINIMIS
1661 WEST AVE #398002
MIAMI BEACH 33239

WWW.MINIM.IS
+1 305 503 5779



MADE SOMEWHERE IN AMERICA.

COPYRIGHT MINIMIS 2023

OCT-2023

VISIBLE LIGHT EFFECT ON SECONDARY SURFACES.*

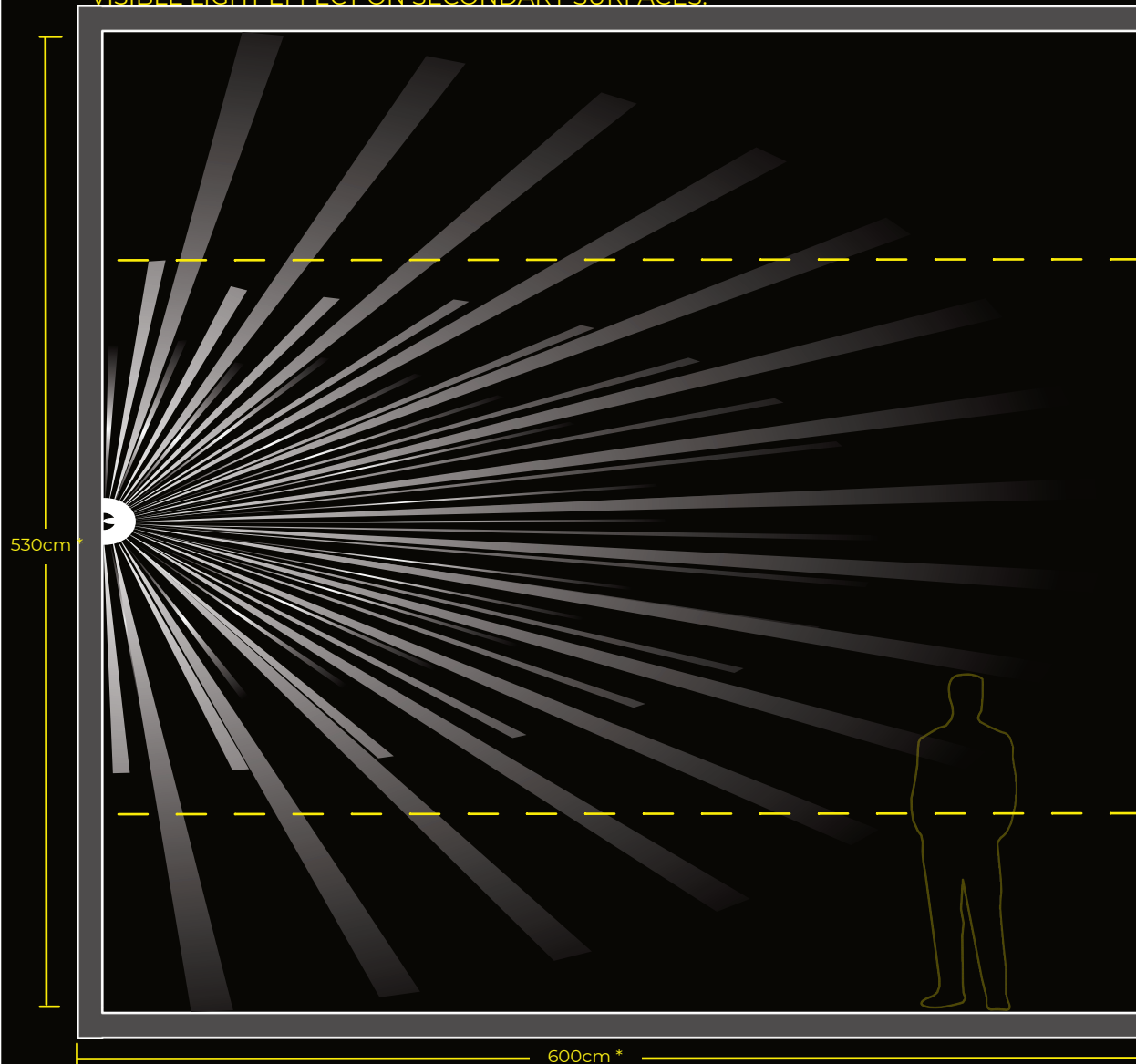

VISIBLE LIGHT EFFECT ON RECESS SURFACE *

* RESULTS BASED UPON NEAR-DARKNESS AND SMOOTH, MATTE-WHITE SURFACES.

RESULTS VARY DEPENDING UPON AMBIENT LIGHT, COLOR AND TEXTURE OF SURFACES BEING ILLUMINATED, AND DISTANCE OF SURFACES ILLUMINATED

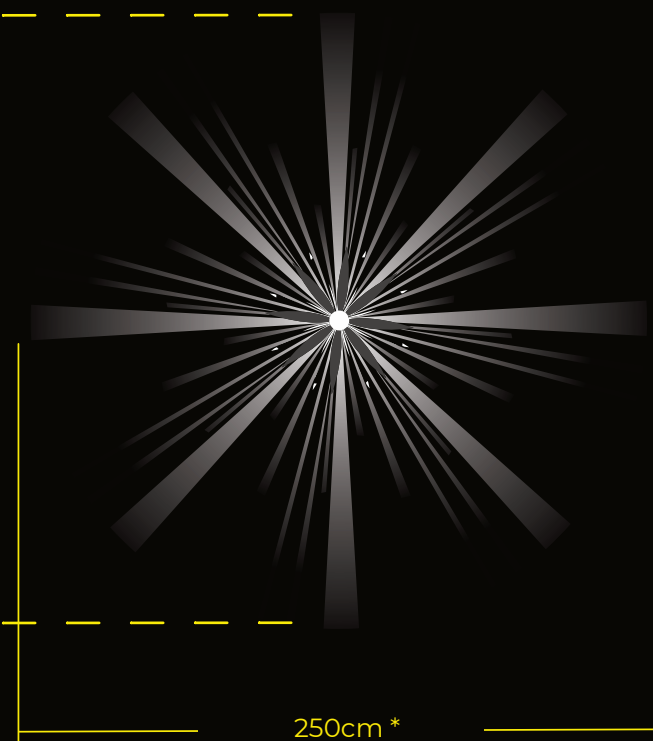

FLECK - TYPE "F"

STUDY OF LIGHT DISTRIBUTION

REV	AO1	SHEET	1/1
-----	-----	-------	-----



REPRESENTATION IS AN APPROXIMATION. SUBJECT TO CHANGE.

PATENT PENDING

ii minimis
MINUSCULE LIGHTING
MICRO-MINUSCULE
INDOOR/OUTDOOR LIGHTING

MADE
SOMEWHERE
IN
FLORIDA.

WWW.MINIMIS.LIGHTING
INFO@MINIMIS
+1.305.503.5779
+1.404.542.4502

MINIMIS
1661 WEST AVE
#398002
MIAMI BEACH, FL 33239

APPROVED
CHECKED
PREPARED 29 JUL 2022

VISIBLE LIGHT EFFECT ON SECONDARY SURFACES. *

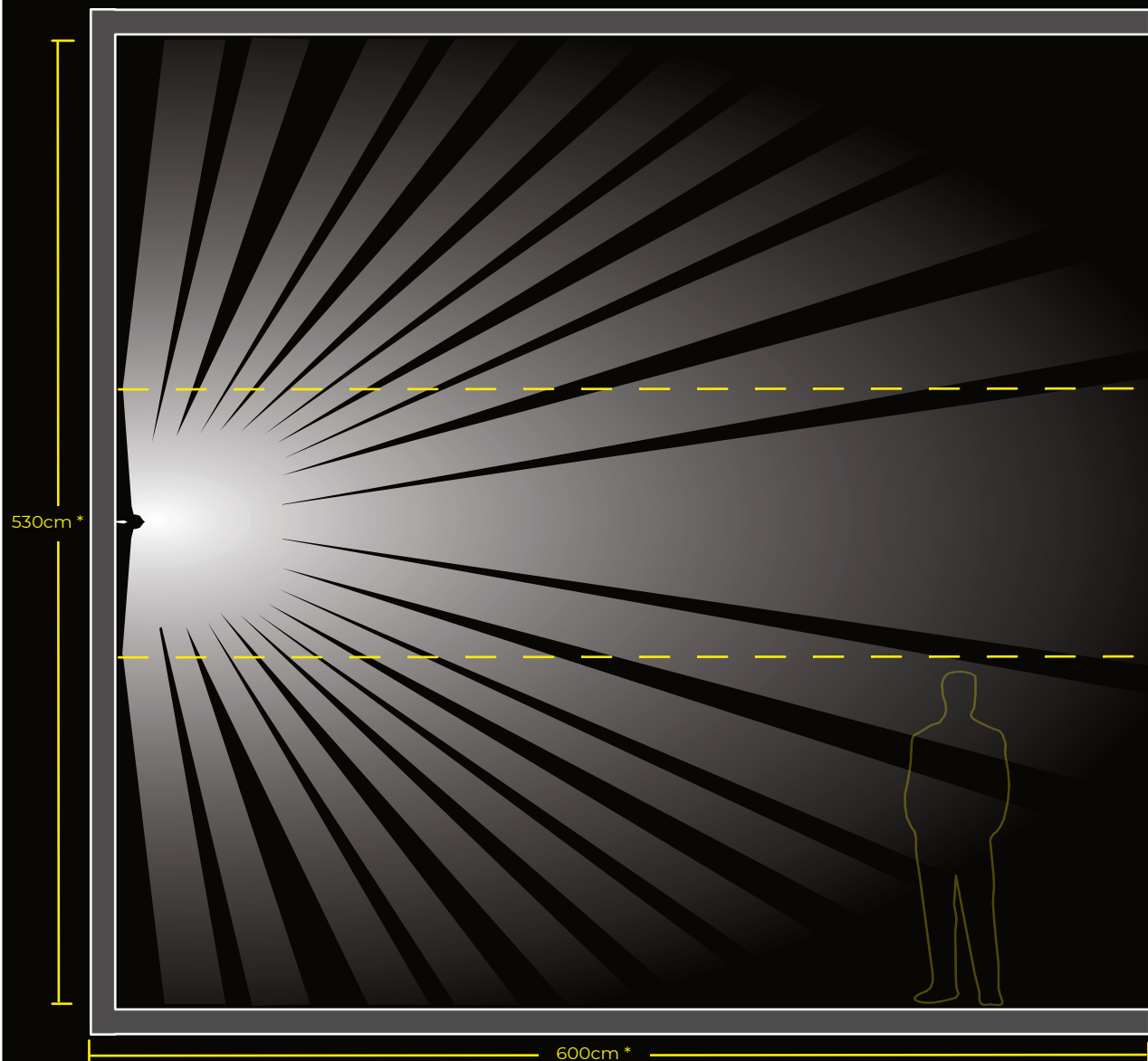

VISIBLE LIGHT EFFECT ON RECESS SURFACE. *

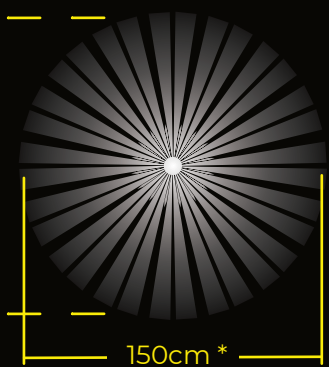

* RESULTS BASED UPON NEAR-DARKNESS AND SMOOTH, MATTE-WHITE SURFACES.

RESULTS VARY DEPENDING UPON AMBIENT LIGHT, COLOR AND TEXTURE OF SURFACES BEING ILLUMINATED, AND DISTANCE OF SURFACES ILLUMINATED.

FLECK TYPE "E" - FLMPXX-E

STUDY OF LIGHT DISTRIBUTION

REV	AO1	SHEET	1/1
-----	-----	-------	-----

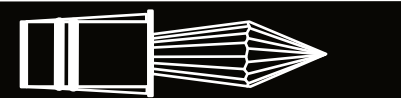

REPRESENTATION IS AN APPROXIMATION. SUBJECT TO CHANGE.

PATENT PENDING

ii minimis
MINUSCULE LIGHT
 MICRO-MINUSCULE
 INDOOR/OUTDOOR LIGHTING

MADE
 SOMEWHERE
 IN
 FLORIDA.

WWW.MINIMIS.LIGHTING
 INFO@MINIMIS
 +1.305.503.5779
 +1.404.542.4502

MINIMIS
 1661 WEST AVE
 #398002
 MIAMI BEACH, FL 33239

APPROVED
 CHECKED
 PREPARED 29 JUL 2022

VISIBLE LIGHT EFFECT ON SECONDARY SURFACES.*



VISIBLE LIGHT EFFECT ON RECESS SURFACE.*

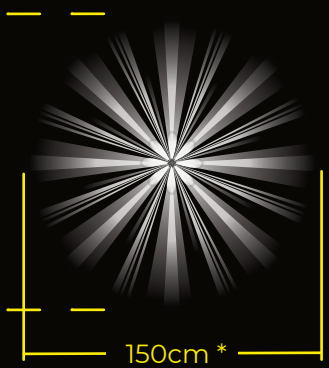

* RESULTS BASED UPON NEAR-DARKNESS AND SMOOTH, MATTE-WHITE SURFACES.

RESULTS VARY DEPENDING UPON AMBIENT LIGHT, COLOR AND TEXTURE OF SURFACES BEING ILLUMINATED, AND DISTANCE OF SURFACES ILLUMINATED.

FLECK TYPE "D" - FLMPXX-D

STUDY OF LIGHT DISTRIBUTION

REV	AO1	SHEET	1/1
-----	-----	-------	-----

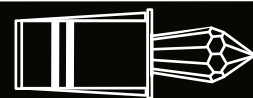

REPRESENTATION IS AN APPROXIMATION. SUBJECT TO CHANGE.

PATENT PENDING

MADE SOMEWHERE IN FLORIDA.	WWW.MINIMIS.LIGHTING	MINIMIS	APPROVED
	INFO@MINIMIS	1661 WEST AVE	CHECKED
	+1.305.503.5779	#398002	PREPARED 29 JUL 2022
	+1.404.542.4502	MIAMI BEACH, FL 33239	

VISIBLE LIGHT EFFECT ON SECONDARY SURFACES. *

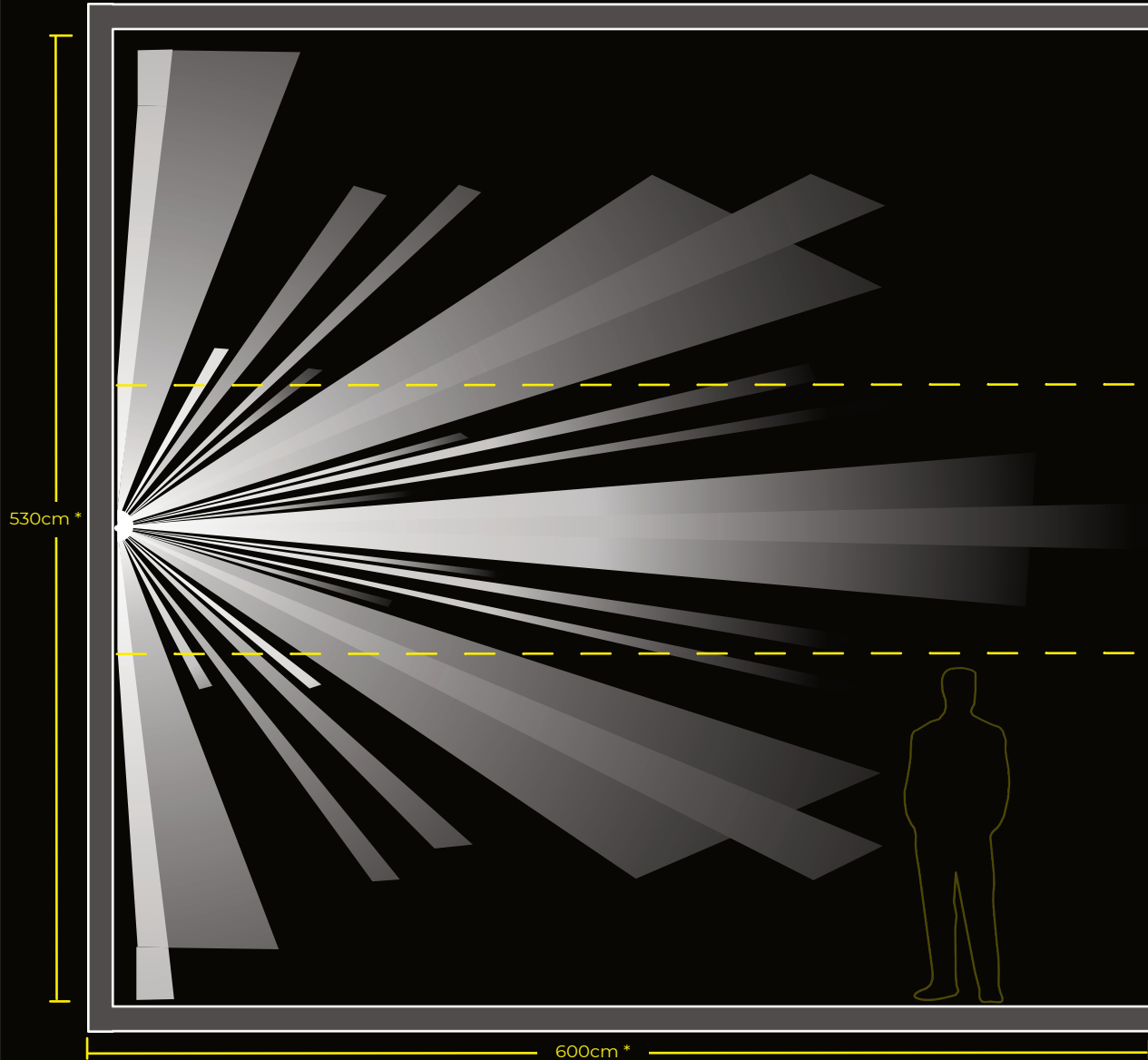

VISIBLE LIGHT EFFECT ON RECESS SURFACE. *

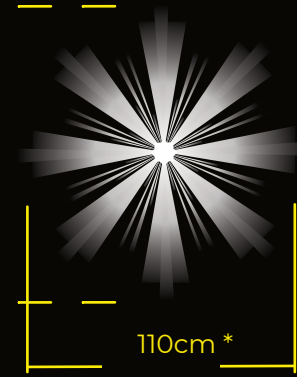

* RESULTS BASED UPON NEAR-DARKNESS AND SMOOTH, MATTE-WHITE SURFACES.

RESULTS VARY DEPENDING UPON AMBIENT LIGHT, COLOR AND TEXTURE OF SURFACES BEING ILLUMINATED, AND DISTANCE OF SURFACES ILLUMINATED.

FLECK TYPE "C" - FLMPXX-C

STUDY OF LIGHT DISTRIBUTION

REV	AO1	SHEET	1/1
-----	-----	-------	-----

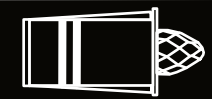

REPRESENTATION IS AN APPROXIMATION. SUBJECT TO CHANGE.

PATENT PENDING

MADE
SOMEWHERE
IN
FLORIDA.

WWW.MINIMIS.LIGHTING
INFO@MINIMIS
+1.305.503.5779
+1.404.542.4502

MINIMIS
1661 WEST AVE
#398002
MIAMI BEACH, FL 33239

APPROVED
CHECKED
PREPARED 29 JUL 2022

VISIBLE LIGHT EFFECT ON SECONDARY SURFACES. *

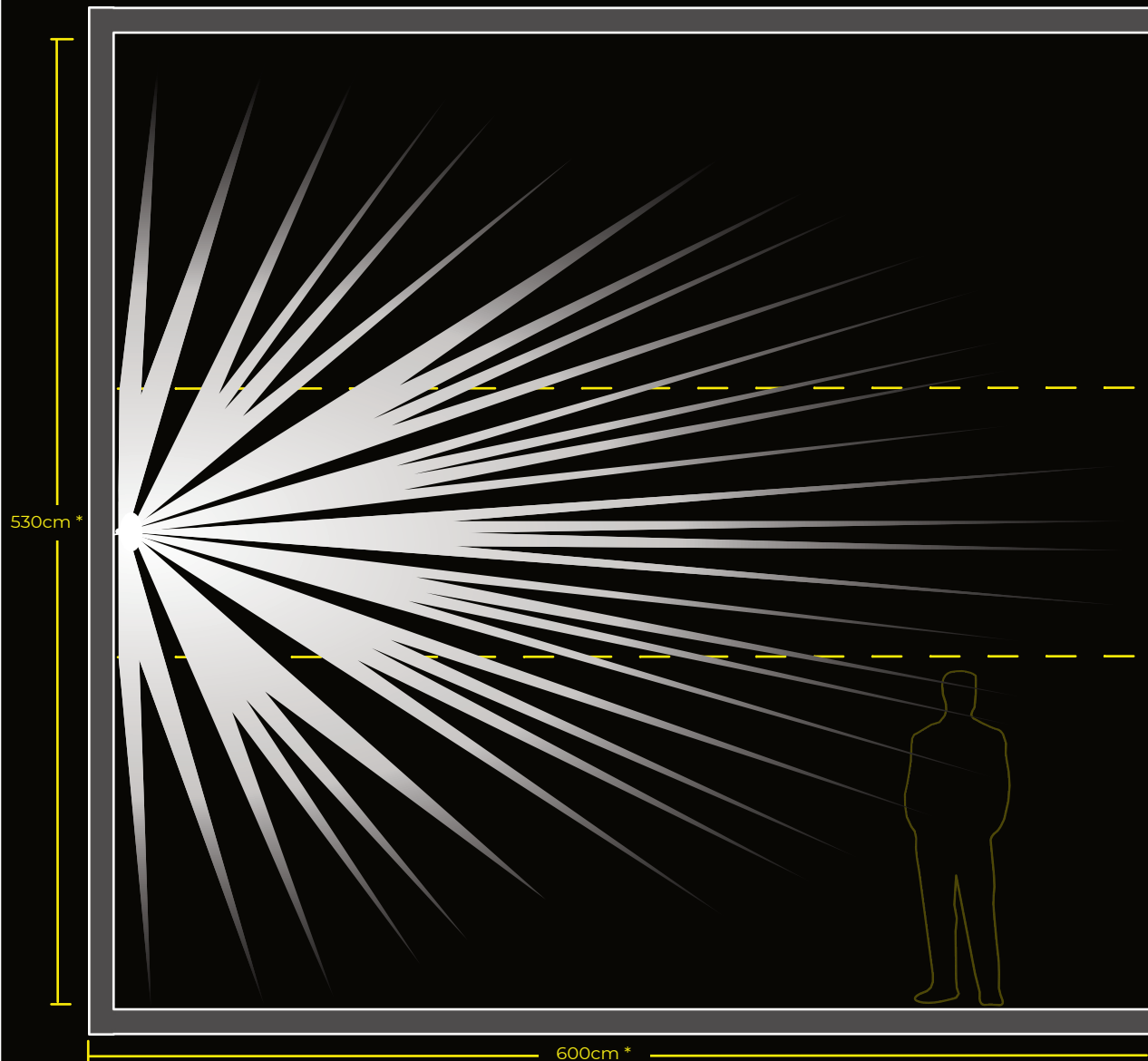

VISIBLE LIGHT EFFECT ON RECESS SURFACE. *

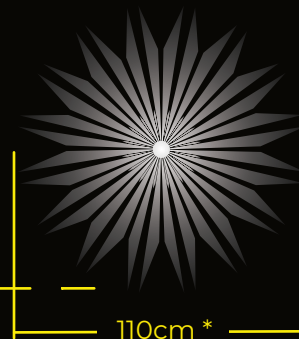

* RESULTS BASED UPON NEAR-DARKNESS AND SMOOTH, MATTE-WHITE SURFACES.

RESULTS VARY DEPENDING UPON AMBIENT LIGHT, COLOR AND TEXTURE OF SURFACES BEING ILLUMINATED, AND DISTANCE OF SURFACES ILLUMINATED.

FLECK TYPE "B" - FLMPXX-B

STUDY OF LIGHT DISTRIBUTION

REV	AO1	SHEET	1 / 1
-----	-----	-------	-------

		CERTIFIED SAFETY US/CA SORTIE US/CA E526650		
				APPROVED
				CHECKED

REPRESENTATION IS AN APPROXIMATION. SUBJECT TO CHANGE.

PATENT PENDING

MADE SOMEWHERE IN FLORIDA.	WWW.MINIMIS.LIGHTING INFO@MINIMIS +1.305.503.5779 +1.404.542.4502	MINIMIS 1661 WEST AVE #398002 MIAMI BEACH, FL 33239	APPROVED
			CHECKED
			PREPARED 29 JUL 2022

VISIBLE LIGHT EFFECT ON SECONDARY SURFACES. *

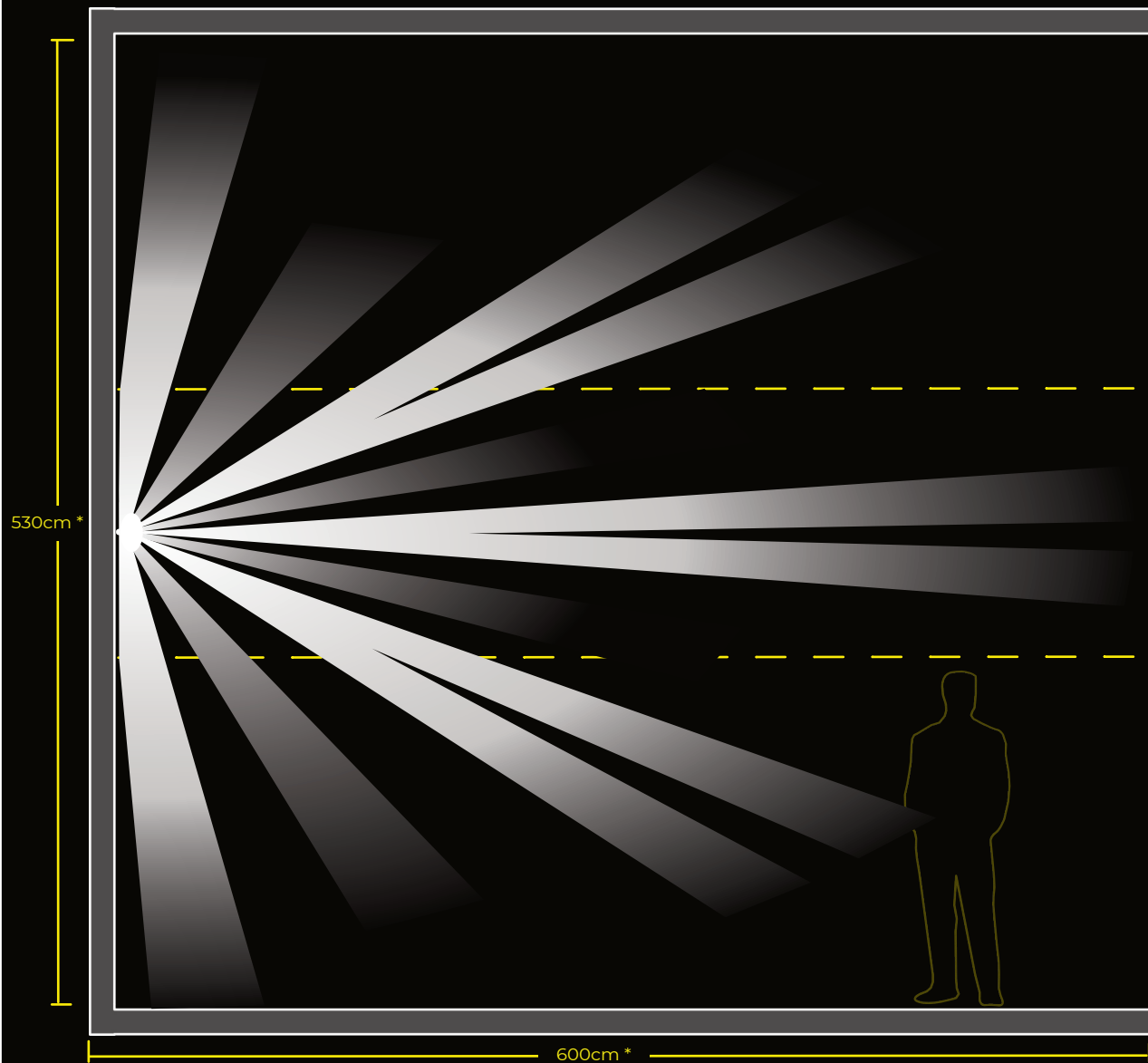

VISIBLE LIGHT EFFECT ON RECESS SURFACE. *

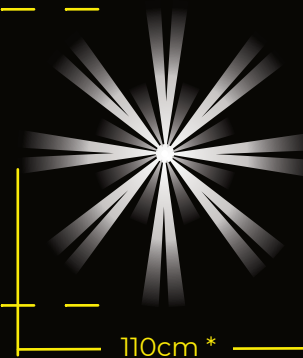

* RESULTS BASED UPON NEAR-DARKNESS AND SMOOTH, MATTE-WHITE SURFACES.

RESULTS VARY DEPENDING UPON AMBIENT LIGHT, COLOR AND TEXTURE OF SURFACES BEING ILLUMINATED, AND DISTANCE OF SURFACES ILLUMINATED.

FLECK TYPE "A" - FLMPXX-A

STUDY OF LIGHT DISTRIBUTION

REV	AO1	SHEET	1 / 1
-----	-----	-------	-------



REPRESENTATION IS AN APPROXIMATION. SUBJECT TO CHANGE.

PATENT PENDING

MADE SOMEWHERE IN FLORIDA.	WWW.MINIMIS.LIGHTING INFO@MINIMIS +1.305.503.5779 +1.404.542.4502	MINIMIS 1661 WEST AVE #398002 MIAMI BEACH, FL 33239	APPROVED
			CHECKED
			PREPARED 29 JUL 2022